

A

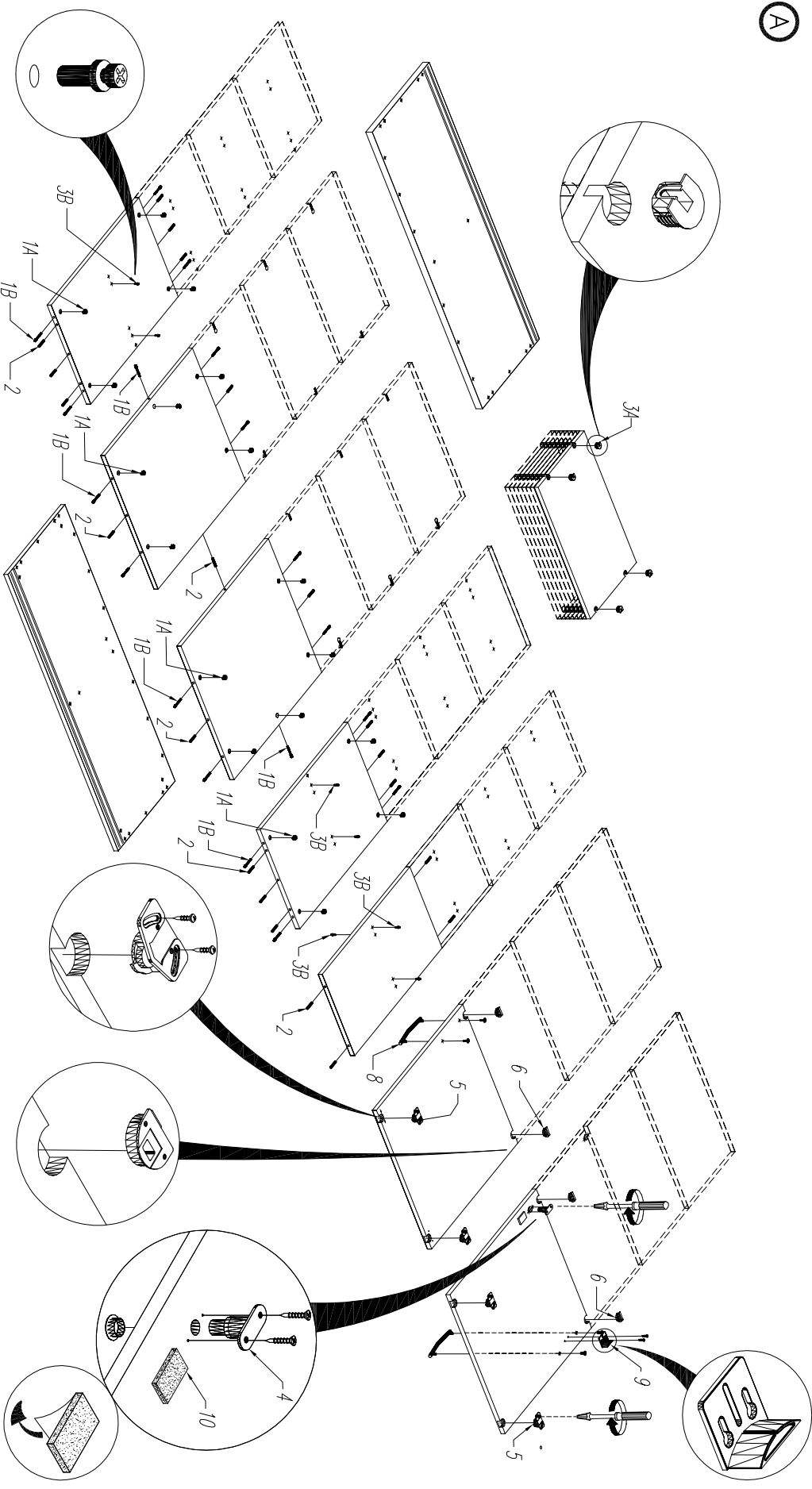

B

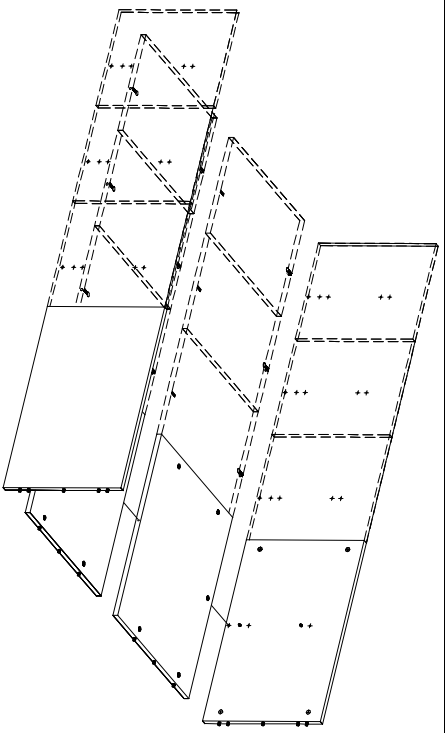

C

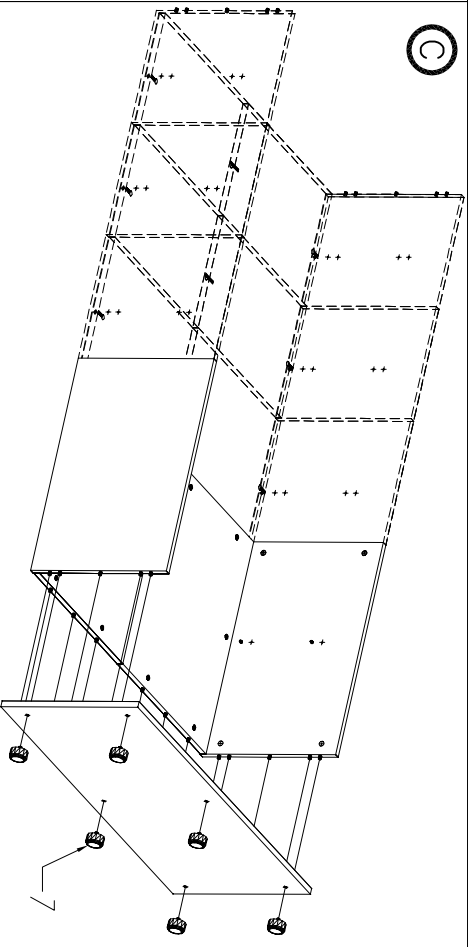

KOLEŃNOŚĆ MONTAŻU
 MIMOSRODOW I KOKKOW.
 THE FITTINGS SEQUENCE OF THE
 CAMS AND DOWELS.
 DIE MONTAGEABFOLGE VON
 EXZENTERN UND DÜBELN.

1

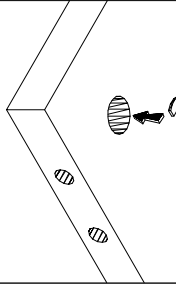

2

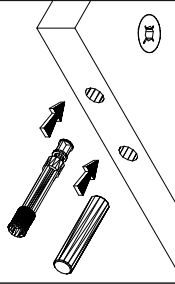

3

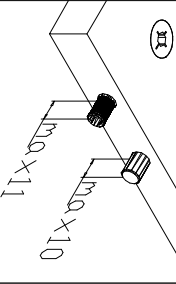

4

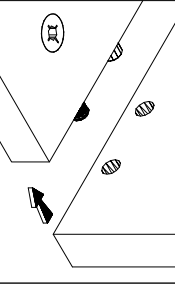

5

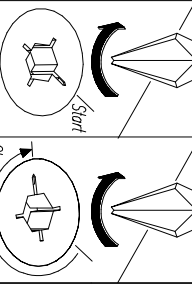

6

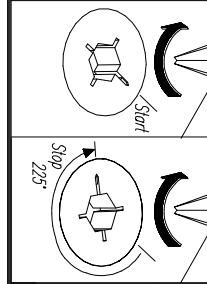

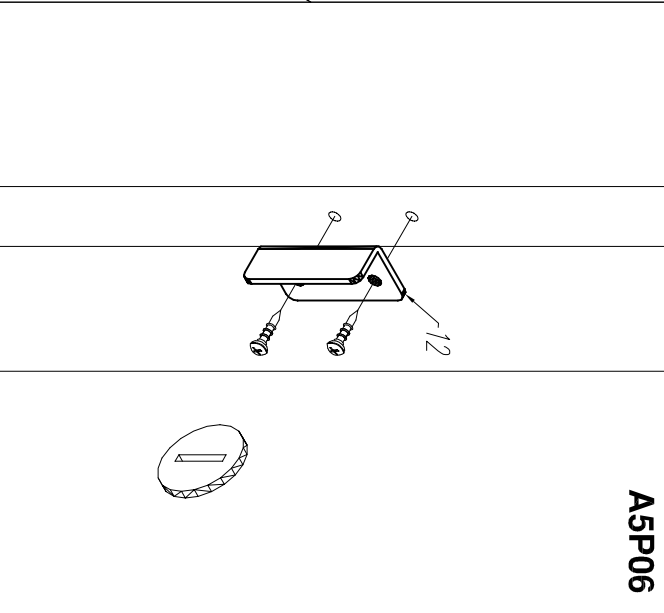
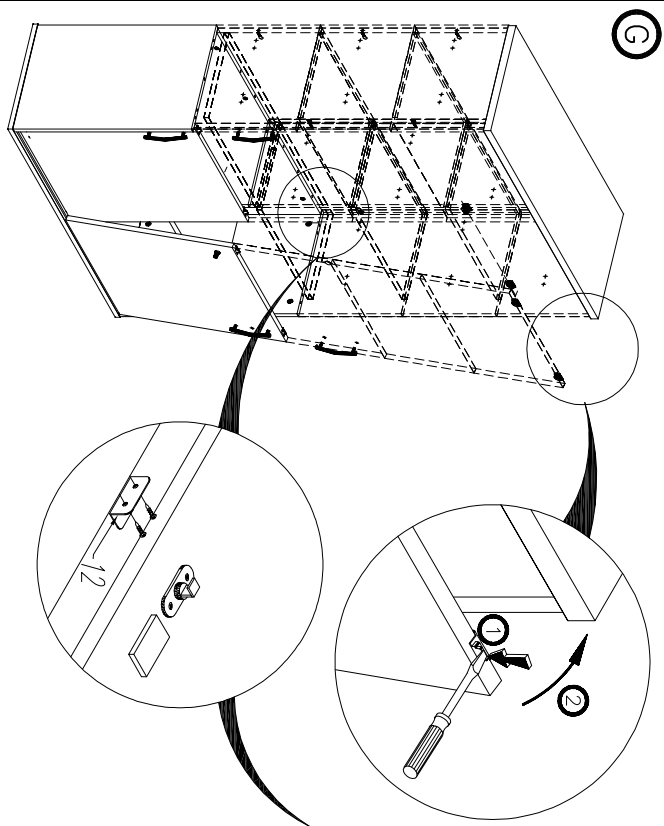
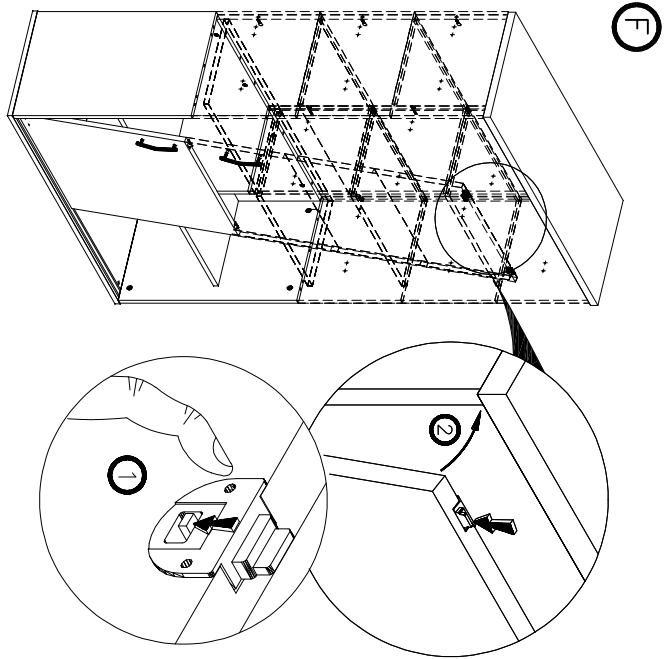

A5P06

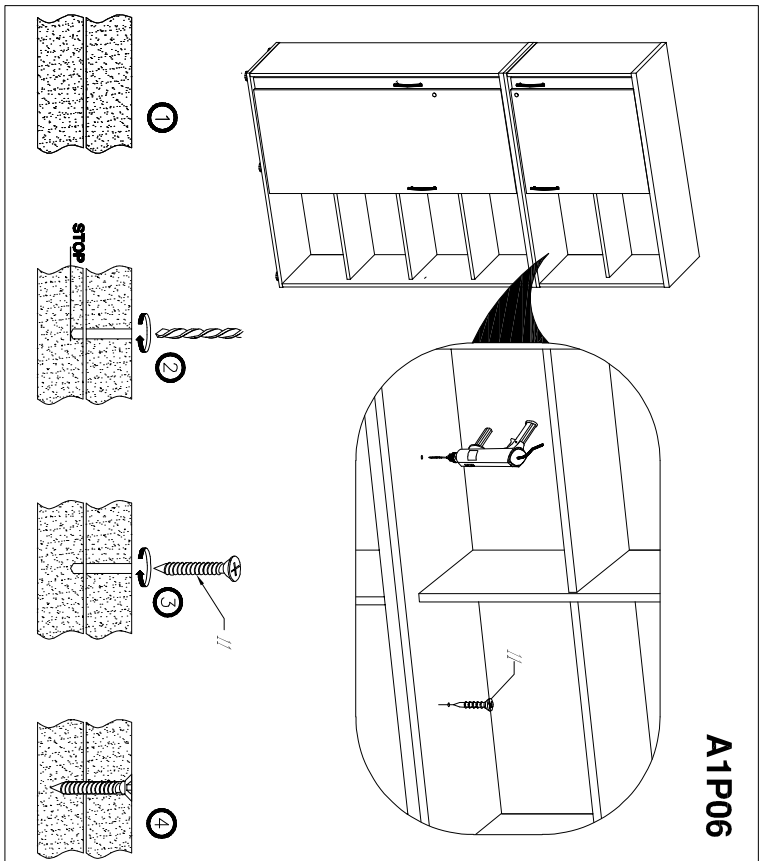
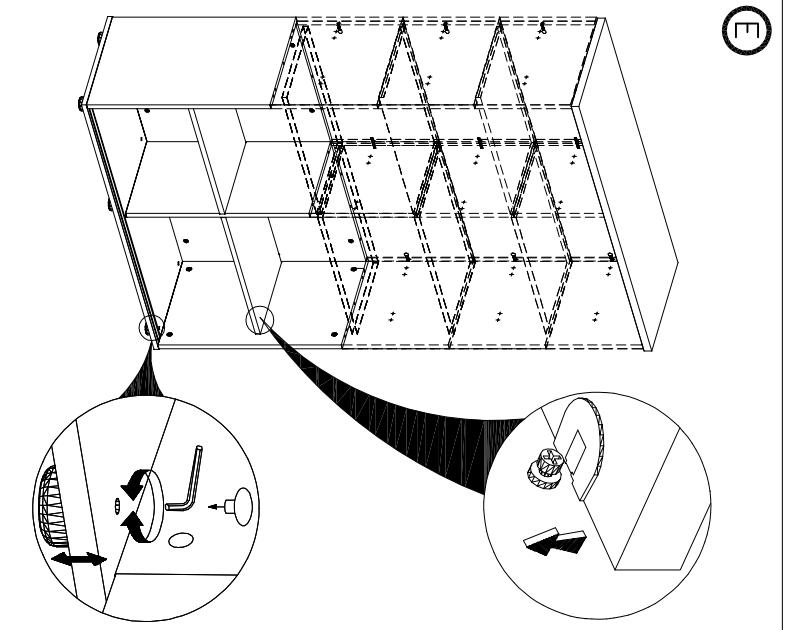
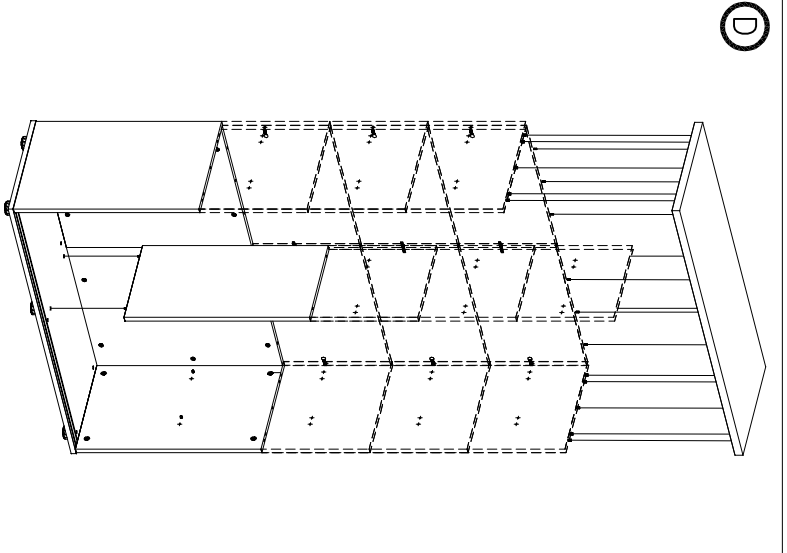

A1P06

